



KINGSTON

Manufacturing reliable industrial valves for industry since 1908.

305A Control Valve

Model 305A

Kingston Quick Opening Industrial Control Valve

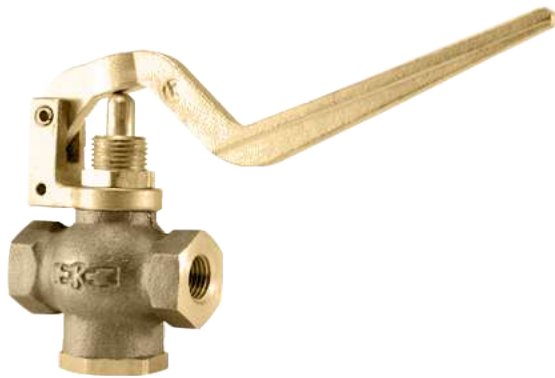

Features

- A Normally Closed, Quick Opening Valve
- Referred to as "Whistle Valve"
- Used on Agricultural and Industrial Applications
- For Air and Liquid Service
- Not Recommended for Steam Service
- Available in 1/4" through 1-1/4"
- Maximum Working Pressure is 400 PSIG @ 60 °F
- Maximum Working Temp. is 200 °F
- Alternative Seals Available
- Alternative Disc, Lever and Cap Options May Be Available. Please Call for Details

Model	Inlet Size	Outlet Size	Dimensions (inches)			Pressure Range (PSIG)	Approx. Shipping Wt.	Max. Temp (°F)
			Height (A)	Width (B)	(C)			
305A	1/4" NPT	1/4" NPT	2-31/32"	2-5/32"	1-1/16"	10-400	10 oz.	200 °F
	3/8" NPT	3/8" NPT					13 oz.	
	1/2" NPT	1/2" NPT	4"	3"	1-9/16"		1 lb. 10 oz.	
	3/4" NPT	3/4" NPT	4-1/4"	3-1/8"	1-27/32"		1 lb. 12 oz.	
	1" NPT	1" NPT	4-1/2"	4"	2-3/8"		2 lb. 4 oz.	
	1-1/4" NPT	1-1/4" NPT	5-1/8"				2 lb. 11 oz.	
						3 lb. 4 oz.		
						3 lb. 8 oz.		
						4 lb.		

Materials

No.	Part Name	Materials
1	Body	Brass
2	Bracket	Infiltrated Iron
3	Lever (Squeeze)	Infiltrated Iron
4	Lever (Pull)	Brass
5	Cap	Brass
6	Stem	Brass
7	Roll Pin	Carbon Steel
8	Spring	Stainless Steel
9	"O" Ring	Buna "N"
10	Nut Stem	Brass
11	Nut Bracket	Brass
13	Cage Disc	Brass
14	Disc Cage	Buna "N"

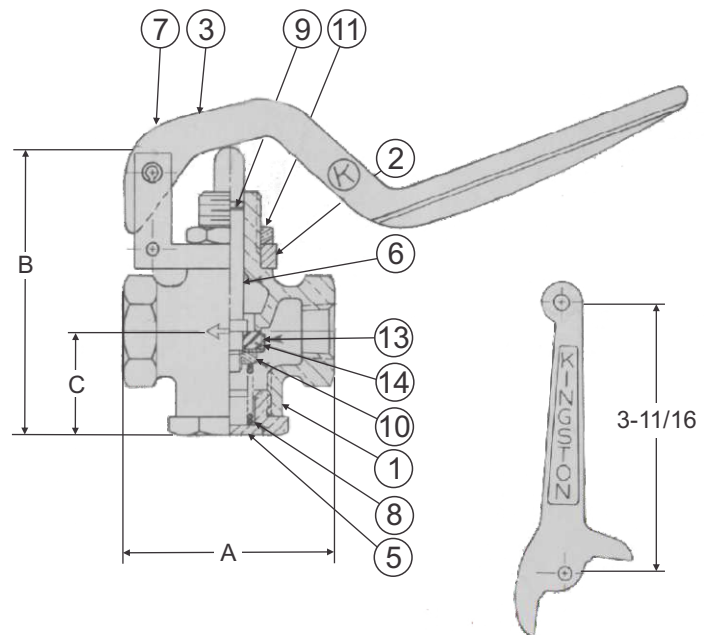

Kingston Model 305A Quick Opening Industrial Control Valve

Flow Capacity Information

Fig. 305 - 1/4" & 3/8"

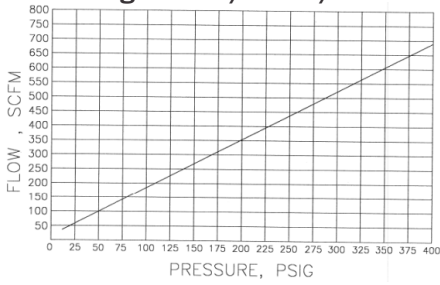

Fig. 305 - 1/2"

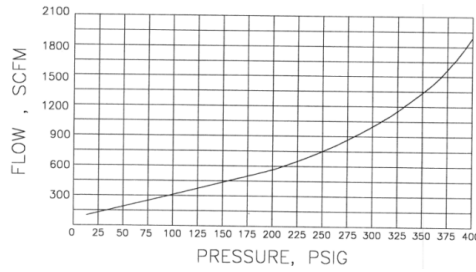

Fig. 305 - 1/2"

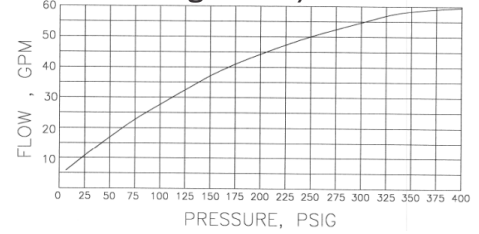

Fig. 305 - 1/4" & 3/8"

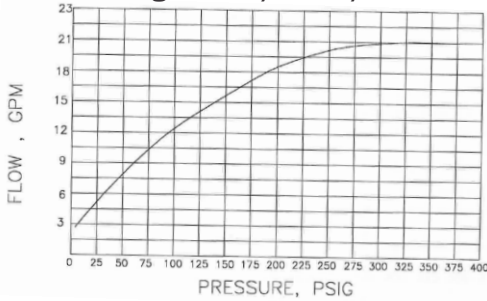

Fig. 305 - 3/4"

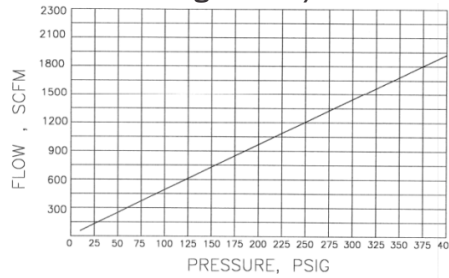

Fig. 305 - 3/4"

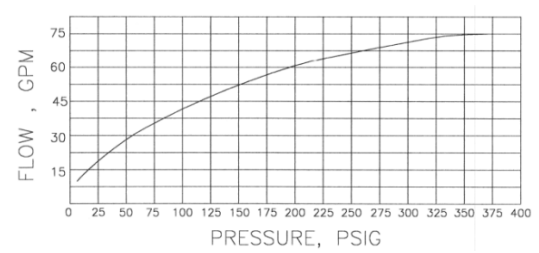

Fig. 305 - 1" & 1-1/4"

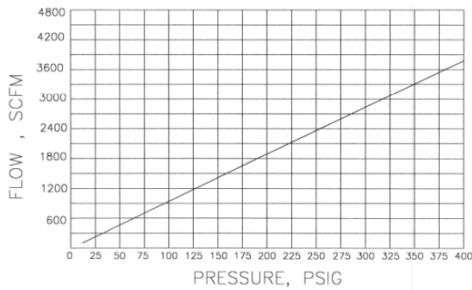

Fig. 305 - 1" & 1-1/4"

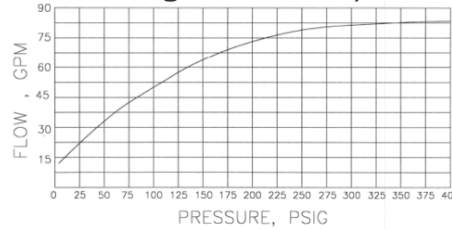
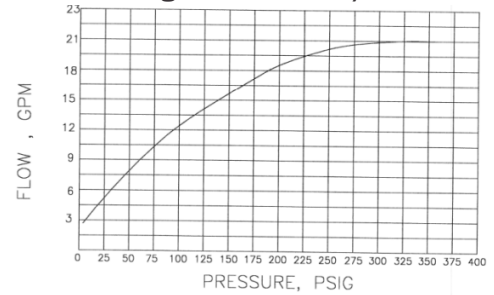

Fig. 305 - 1" & 1-3/8"



Product Notes

Storm Manufacturing reserves all rights. Product specifications and designs are subject to change without notice.

The information contained herein by Storm Manufacturing Group (SMG) is provided in good faith and as a product guide only. Further, SMG makes no representation as to the completeness or accuracy of the information contained herein. Any person or persons using the information contained herein must exercise their own judgement and consider all local, regional, nation and global safety standards in evaluating valve selection options. Final application design and integration of Kingston Products are the sole responsibility of the end user.

Ordering Information

Kingston Air Actuators (305A) Part Number Codes

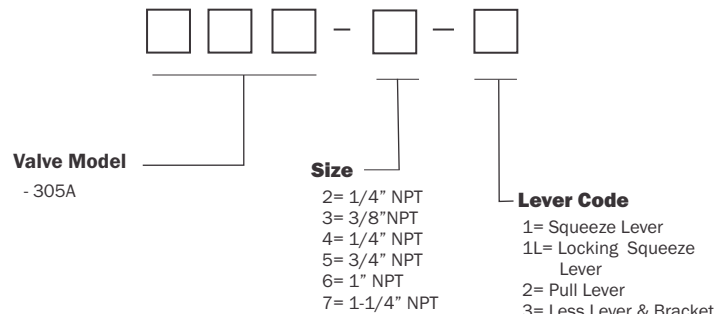

www.KingstonValves.com
KINGSTON